

# LT-3800-5A LED RGB Controller

## User's Manual



(Please read this manual carefully before use)

## Forward

Thanks for choosing our LT-3800-5A RGB Controller. Before installation and usage, we strongly recommend you to read through this manual carefully.

## After-Sales

From the day you purchase our products within a year, if being used properly in accordance with the instruction, and quality problems occur, we provide free repair or replacement services except the following cases:

1. Any defects caused by wrong operations..
2. Any damages caused by inappropriate power supply or abnormal voltage.
3. Any damages caused by unauthorized removal, maintenance, modifying circuit, incorrect connections and replacing chips.
4. Any damages due to transportation, breaking, flooding water after the purchase.
5. Any damages caused by earthquake, fire, flood, lightning strike etc force majeure of natural disasters.
6. Any damages caused by negligence, inappropriate storing at high temperature and humidity environment or near harmful chemicals.
7. Product has been updated.

## Safety warnings

1. Please don't install this controller in lightening, intense magnetic and high-voltage fields.
2. To reduce the risk of component damage and fire caused by short circuit, make sure correct connection
3. Always be sure to mount this unit in an area that will allow proper ventilation to ensure a fitting temperature.
4. Check if the voltage and power adapter suit the controller (**please select DC5-24V power supply with constant voltage**)
5. Don't connect cables with power on, make sure a correct connection and no short circuit checked with instrument before power on.
6. Please don't open controller cover and operate if problems occur.

The manual is only suitable for this model, any update is subject to change without prior notice.

## Product Brief

LT-3800-5A RGB controller is a unique DIY version as well as a powerful combination that can control color changes of LED lights with 4-pin 3-loop cables (common anode), built-in 18 modes with touch functional buttons, provided with IR wireless remote control panel, users can control color changes of LED light by pressing the button on the controller or on the remote control panel, very users friendly.

### I . Technical Specs

#### LT-3800-5A Constant voltage controller

---

Input voltage	DC5V~DC24V
Max load current	5A/CH×3
Max load power	75W /180W/ 360W(5V/12V/24V)
Changing mode	18mode
Scale level	256 steps per RGB
Static dimming	mixing up 4096 colors
Dimension	L142×W73×H30mm
Package Size	L145×W88×H46mm
Weight (G.W)	350g

### II . Features

1. Automatic switch from DC5-DC24V;
2. With 24 Buttons IR Wireless remote control, reliable control distance can reach as far as 10m;
3. Several DIY Storage Buttons, to record your favorite effect ;
4. 0-100% dimming and 16 levels of static brightness per RGB, can mix 4096 colors.
5. 3-Channel RGB full color control, maximum outputs 5A per Channel.
6. 256 Grey scales per RGB, color-smooth effect is gentle and accurate.
7. Can choose changing speed separately and adjust the brightness

of each mode.

8. Can rest at current color and color depth by selecting PAUSE function.
9. Working with our LT-3060, can expand power unlimitedly.

### III. Product Dimension

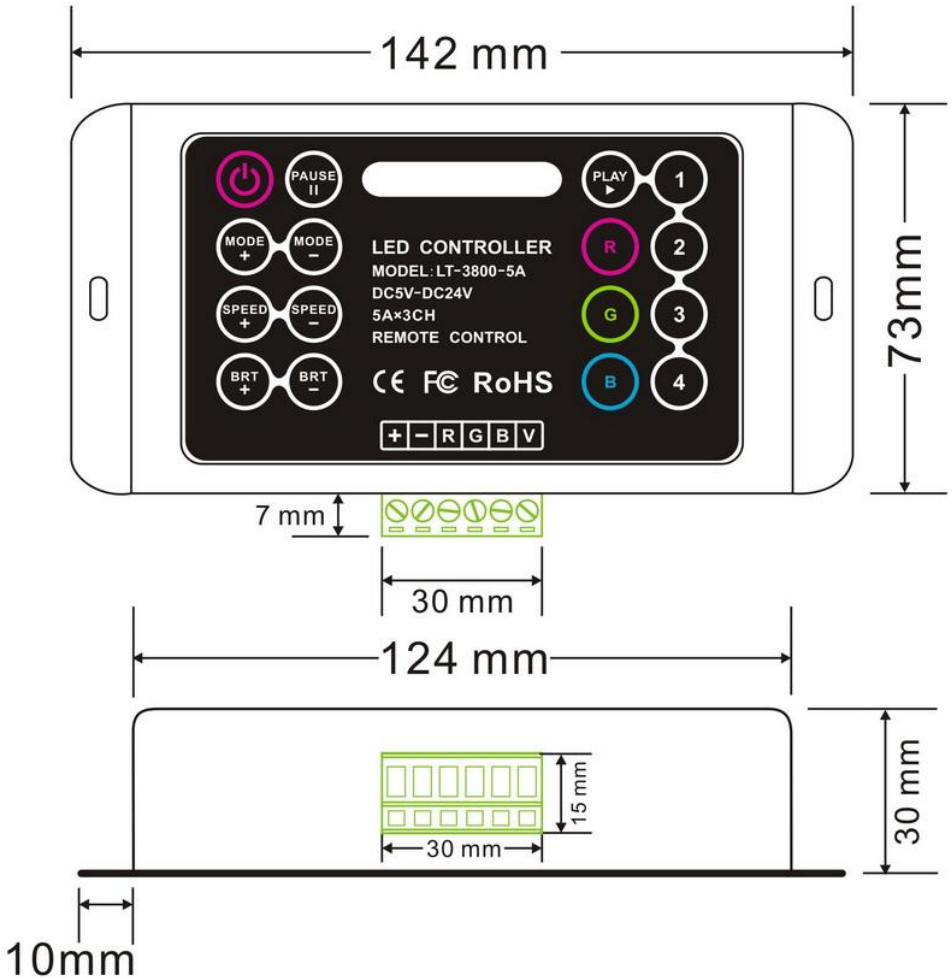

Dimension of controller

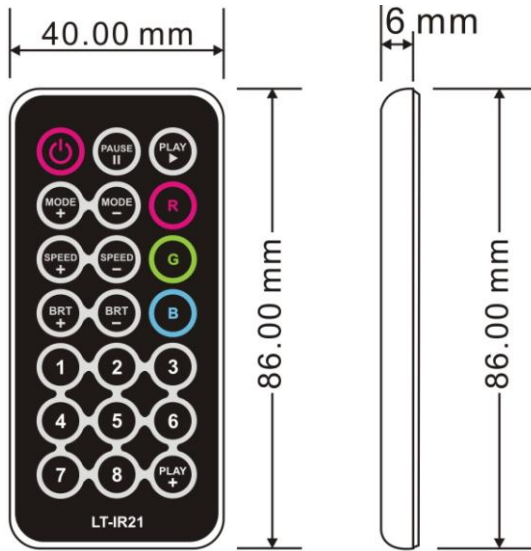

Dimension of IR remote

#### IV. Conjunction diagram

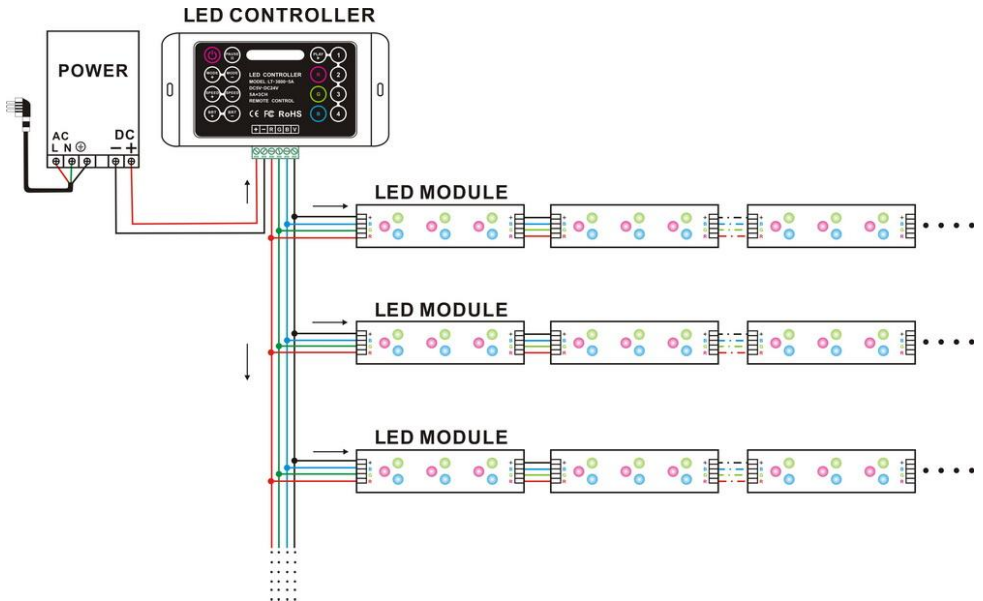

# V, Operating instructions

## 1, Instructions of controller and remote's keys:

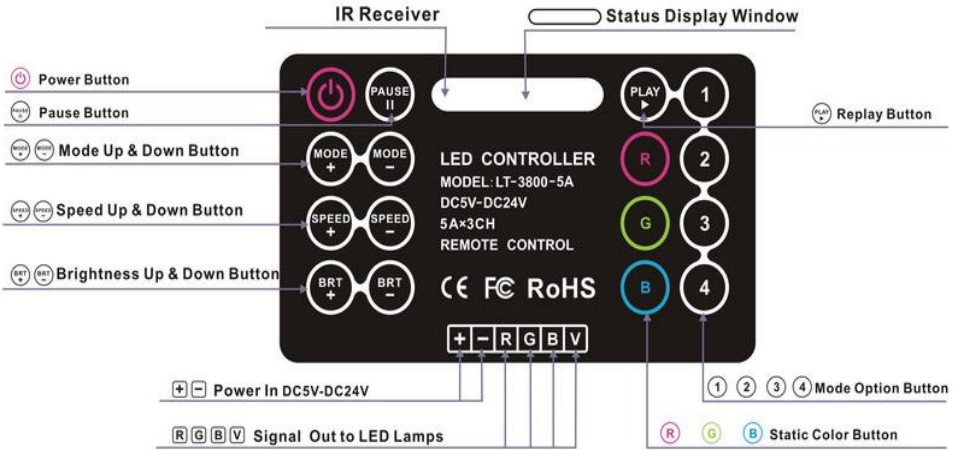



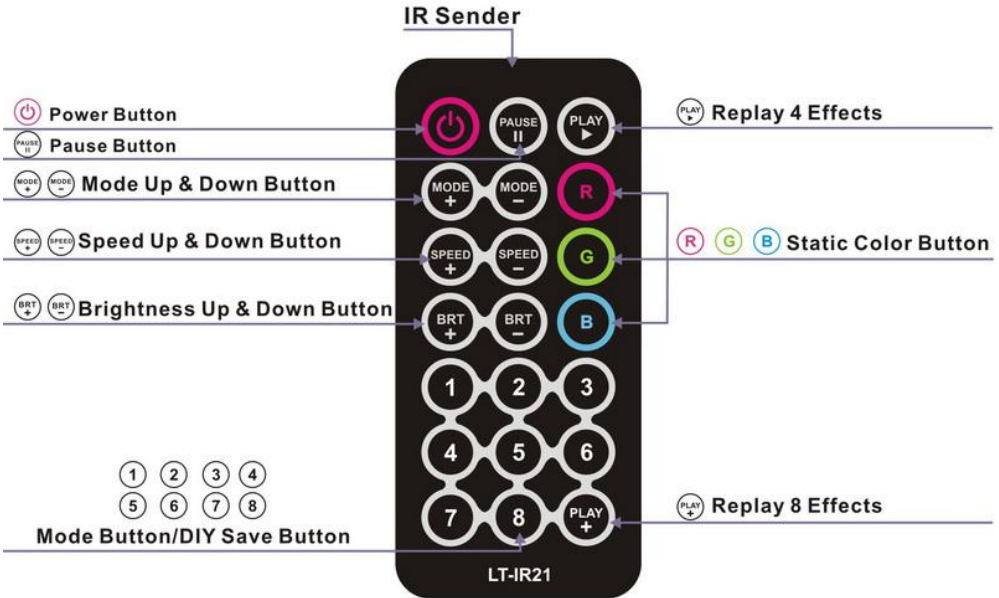





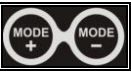

Instruction of controller's buttons

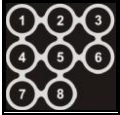

Instruction of IR remote's buttons

## 2. Detailed key functions

Sign	Button	Description
	<b>ON /OFF</b>	Turn on/off the controller  Any button can start the controller at off status.
	<b>PAUSE</b>	Press this button will rest at current color, it will continue to change if press again. Press this button in 3 seconds, the buzzer can be on or off.
	<b>MODE+ MODE-</b>	Press them to select next mode or back to previous mode (pls refer to the VI item) , press MODE+ or press MODE- over 3s to enter cycle mode.
	<b>SPEED+ SPEED-</b>	Press them to quicken or slower speed, press SPEED+ or SPEED- over 3s, current speed is restored to Default status.
	<b>BRT+ BRT-</b>	Press them to increase or decrease brightness, press any one over 3s, current brightness is restored to Default status.
	<b>DIY modes</b>	Press them over 3s, LED flickers twice, then remember current change mode on this button, it can save 4 modes, just press it once then enter into pre-setup mode.
	<b>DIY modes of remote</b>	Press them over 3s, LED flickers twice, then remember the current mode on this button, it can save 8 modes, later can reach your pre-setup mode by just pressing it once.
	<b>PLAY</b>	Cycle play the 4 pre-setup modes in controller.

	<p><b>PLAY+</b></p>	<p>Cycle play the 8 pre-setup modes in IR remote controller.</p>
	<p><b>RGB Dimming key</b></p>	<p>1.Press single R, G, B key continuously to change the brightness of RGB LED. 2. In single R, G or B dimming status, press BRT+/BRT- key to increase/decrease the brightness.of current LED</p>

**Note:** 1.The functions of 1-4 DIY keys on the controller are the same with the 1-4 DIY keys on the remote controller.

2. The cycle play buttons can only play the dynamic changing effects, if DIY reserved a static color, the static color will be skipped when pressing the cycle paly button.

VI. Tables of changing modes

Sequence	Modes	Description	Remark
1	Static red	Normally on red	Brightness adjustable
2	Static green	Normally on green	Brightness adjustable
3	Static blue	Normally on blue	Brightness adjustable
4	Static yellow	Normally on yellow	Brightness adjustable
5	Static purple	Normally on purple	Brightness adjustable
6	Static cyan	Normally on cyan	Brightness adjustable
7	Static white	Normally on white	Brightness adjustable



8	3-color skipping	Red, green and blue 3-color skipping	Brightness and speed adjustable
9	7-color skipping	Red, green, blue, yellow, purple, cyan, white 7-color skipping	Brightness and speed adjustable
10	White color strobe	White (with all red, green and blue on) strobe	Brightness and speed adjustable
11	3-color smooth	RGB 3-color gradual changes	Brightness and speed adjustable
12	Full color smooth	All 7-color gradual changes	Brightness and speed adjustable
13	RG color smooth	Red, green 2-color gradual changes	Brightness and speed adjustable
14	RB color smooth	Red, blue 2-color gradual changes	Brightness and speed adjustable
15	GB color smooth	Green, blue 2-color gradual changes	Brightness and speed adjustable
16	White color fade & change	white (with red, green & blue on) gradual bright & fade	Brightness and speed adjustable
17	Great cycle	All changing modes overlap cycle	/
18	RGB static dimming	0-100% dimming per RGB	16 levels of brightness per RGB

**VIII. Exception Handles**

Malfunction	Causation	Settle
No light	1. No power from plug 2. Power supply protection works 3. Incorrect connection or cable loose	1、 Check the socket 2、 Check the malfunction, re-power on 3、 Check connection
Incorrect color	4. Incorrect RGB output wire connection	4、 Re-connect RGB wires correspondently
No changes for certain mode	5. Speed is too slow	5、 Press Speed to accelerate
Uneven brightness of LED between front and rear	6. Output cable is too long 7. Wire diameter is too small 8. Overload beyond power capability 9. Overload beyond controller capability	6、 Reduce cable or use daisy-chain power 7、 Change wider wire 8、 Change power supply 9、 Add power amplifier